

SECTION A-A

UNLESS OTHERWISE SPECIFIED: DIMENSIONS ARE IN MILLIMETERS SURFACE FINISH: TOLERANCES: LINEAR: ANGULAR:				FINISH:		DEBUR AND BREAK SHARP EDGES		DO NOT SCALE DRAWING		REVISION	
DRAWN				SIGNATURE		DATE		TITLE:			
CHK'D											
APPV'D											
MFG											
Q.A						MATERIAL:		DWG NO.		100.365	
								SCALE:1:1		SHEET 1 OF 1	
										A4	

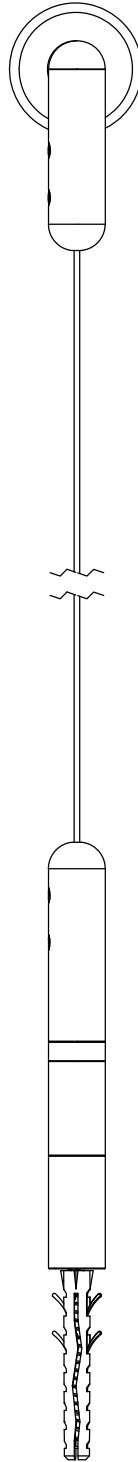

Title :
Wire Cable Set Wall to Floor

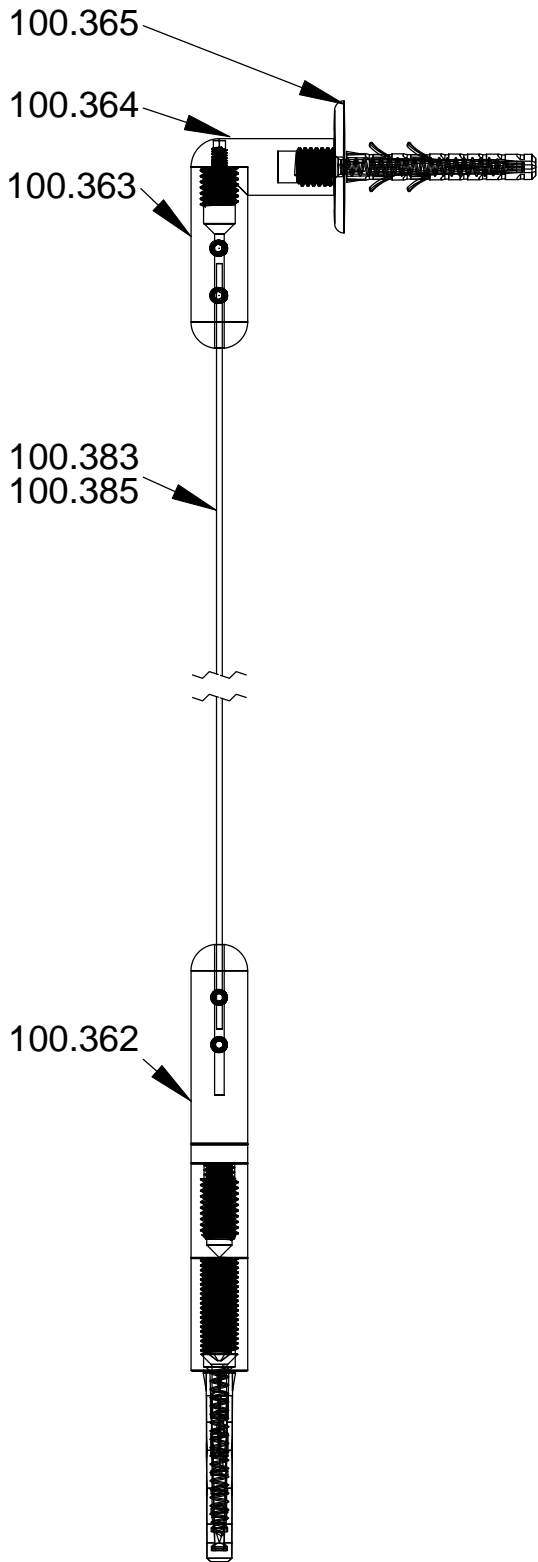
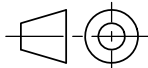

Scale : 1:5

Mbs R&D

Sizes : Letter Portrait

Customer:



MBS Sign USA
Tel.: 352-593-4151
Fax: 352-796-4437
Brooksville, FL

Material:

Finish

Qty :

Rep :

N°programme laser

N°prog. Mécanum.

N° Plan : Wire Cable set Wall to floor

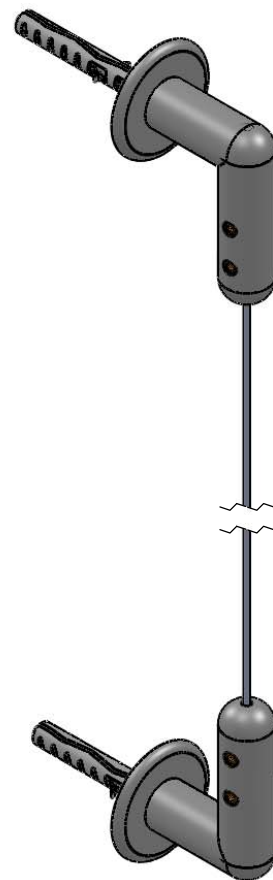
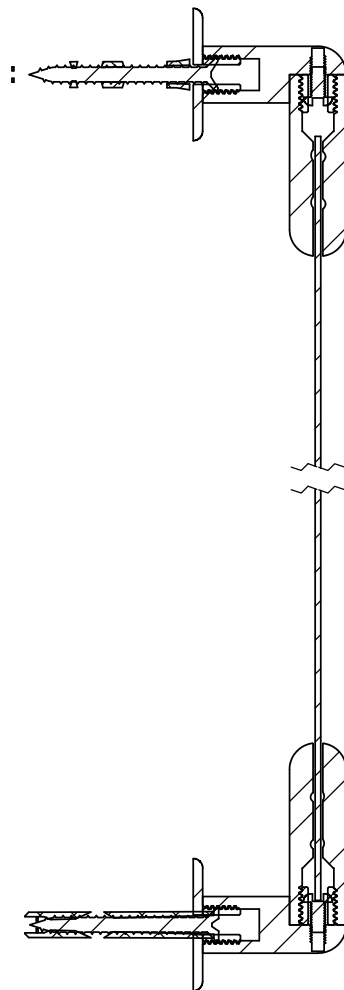
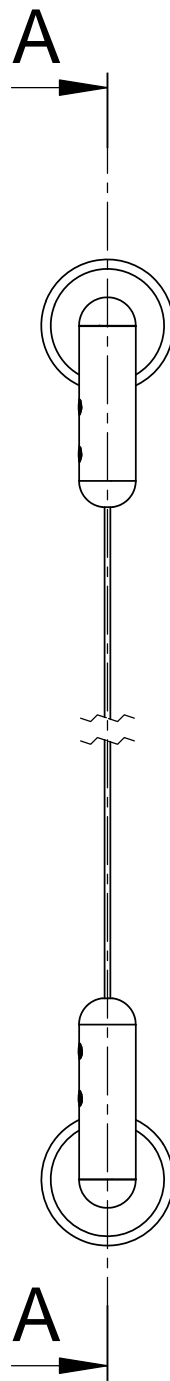
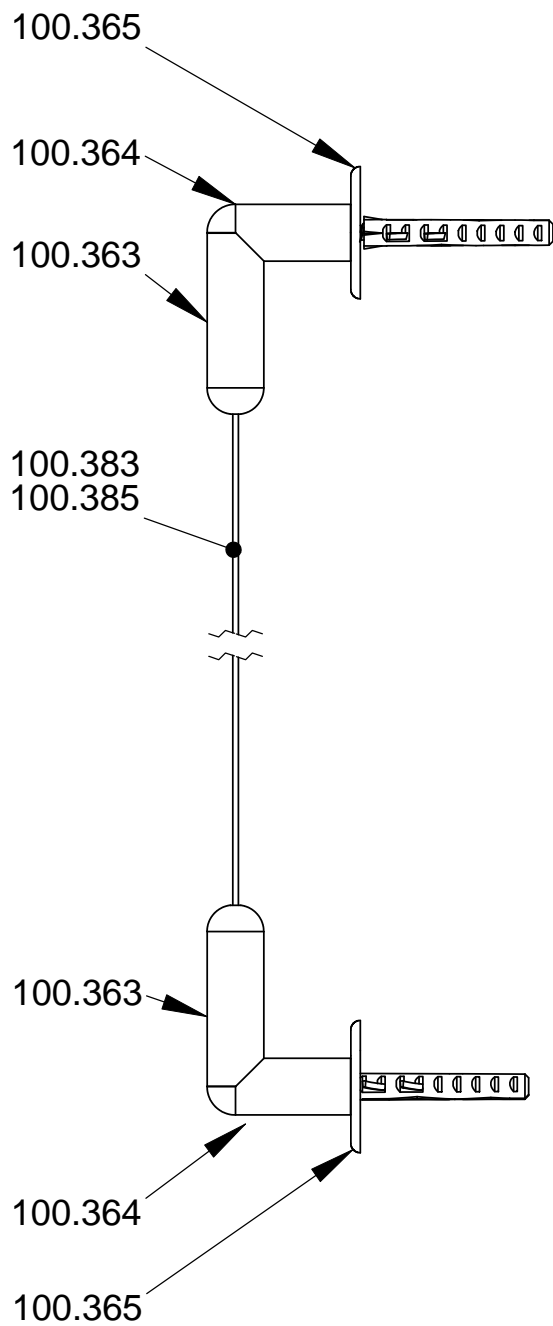

SECTION A-A
SCALE 1 : 2

Title :
Wire_Cable-Set_Wall_to_Wall

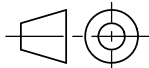

Scale : 1:5

Mbs R&D

Sizes : Letter Portrait

Customer:



MBS Sign USA
Tel.: 352-593-4151
Fax: 352-796-4437
Brooksville, FL

Material:

Finish

Qty :

Rep :

N°programme laser

N°prog. Mécanum.

N° Plan : Wire_Cable-Set_Wall_to_Wall



Construction Examples:

