

Title : ZCP2-6			Scale : 1:1		Mbs R&D	
			Sizes : Letter Landscape		Customer:	
Material:		Finish		Qty :	Rep :	
N°programme laser		N°prog. Mécanum.		N° Plan : ZCP1-3ft		
Mbs Standoffs 6420 Benjamin Rd Tampa, FL 33634 USA 813-938-6025						

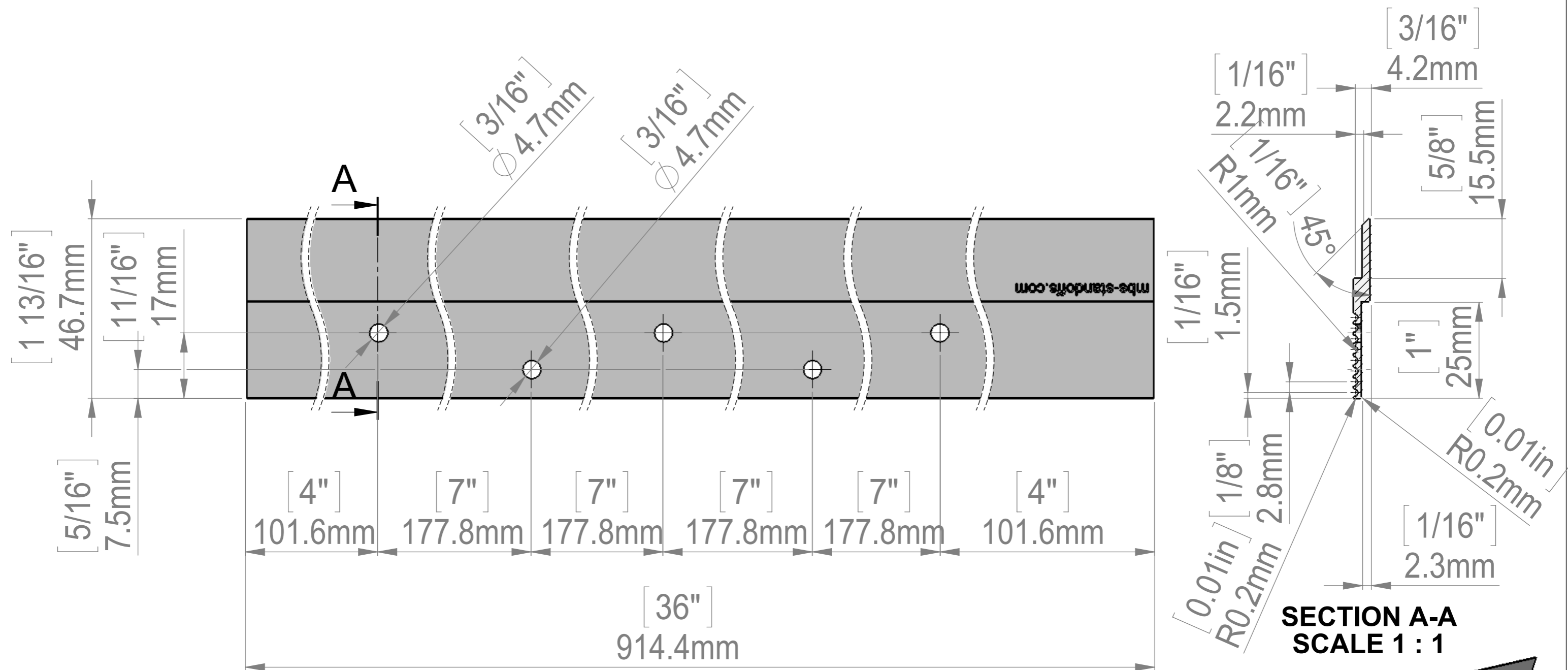

**SECTION A-A
SCALE 1 : 1**

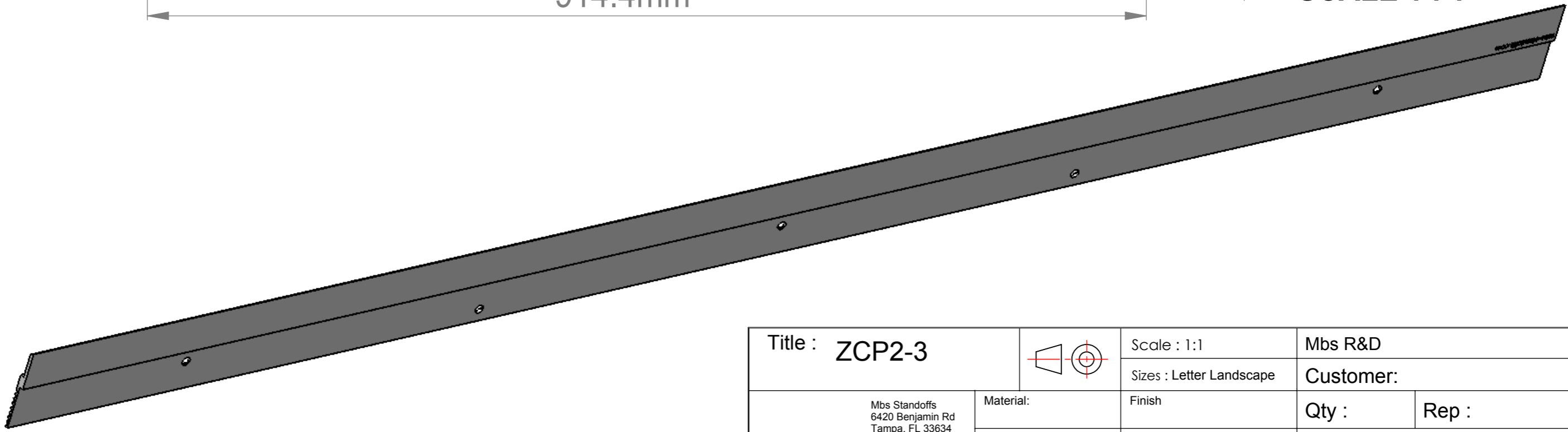

Title : ZCP2-3			Scale : 1:1	Mbs R&D	
Mbs Standoffs 6420 Benjamin Rd Tampa, FL 33634 USA 813-938-6025			Sizes : Letter Landscape	Customer:	
Material:		Finish	Qty :	Rep :	
N°programme laser		N°prog. Mécanum.	N° Plan : ZCP1-3ft		

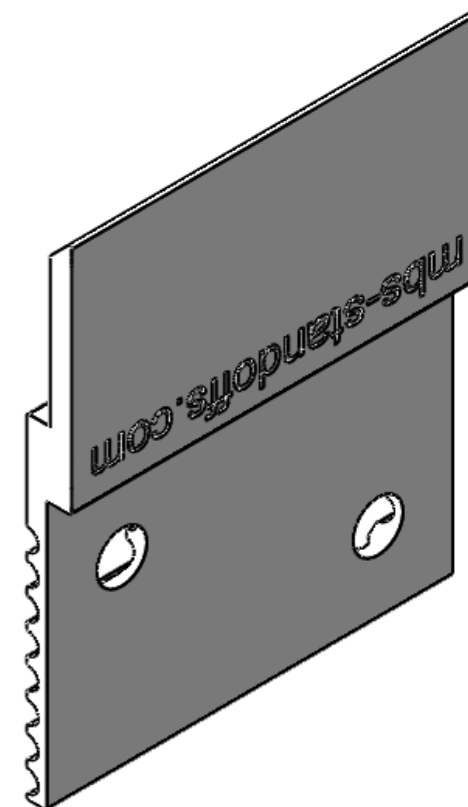
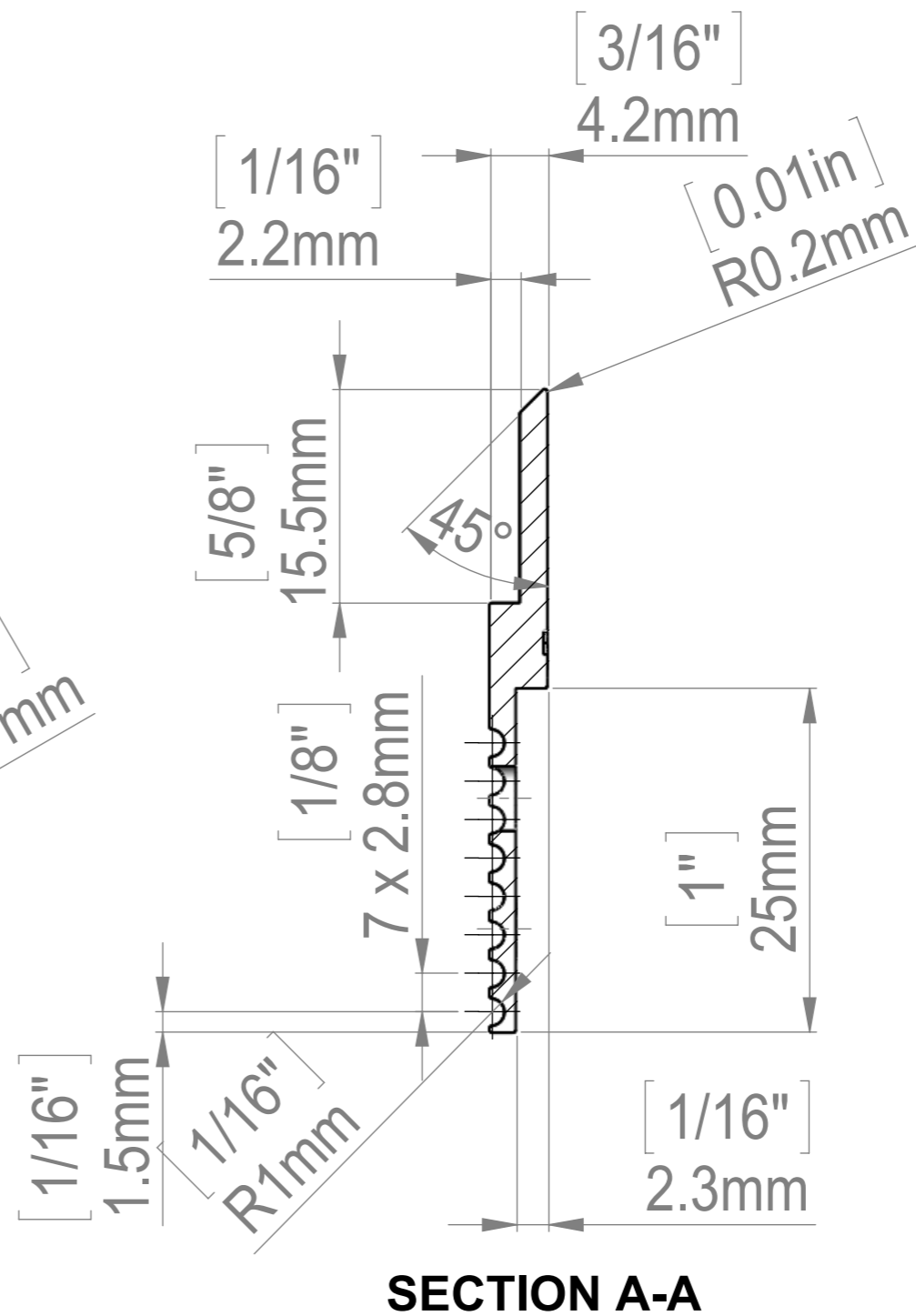
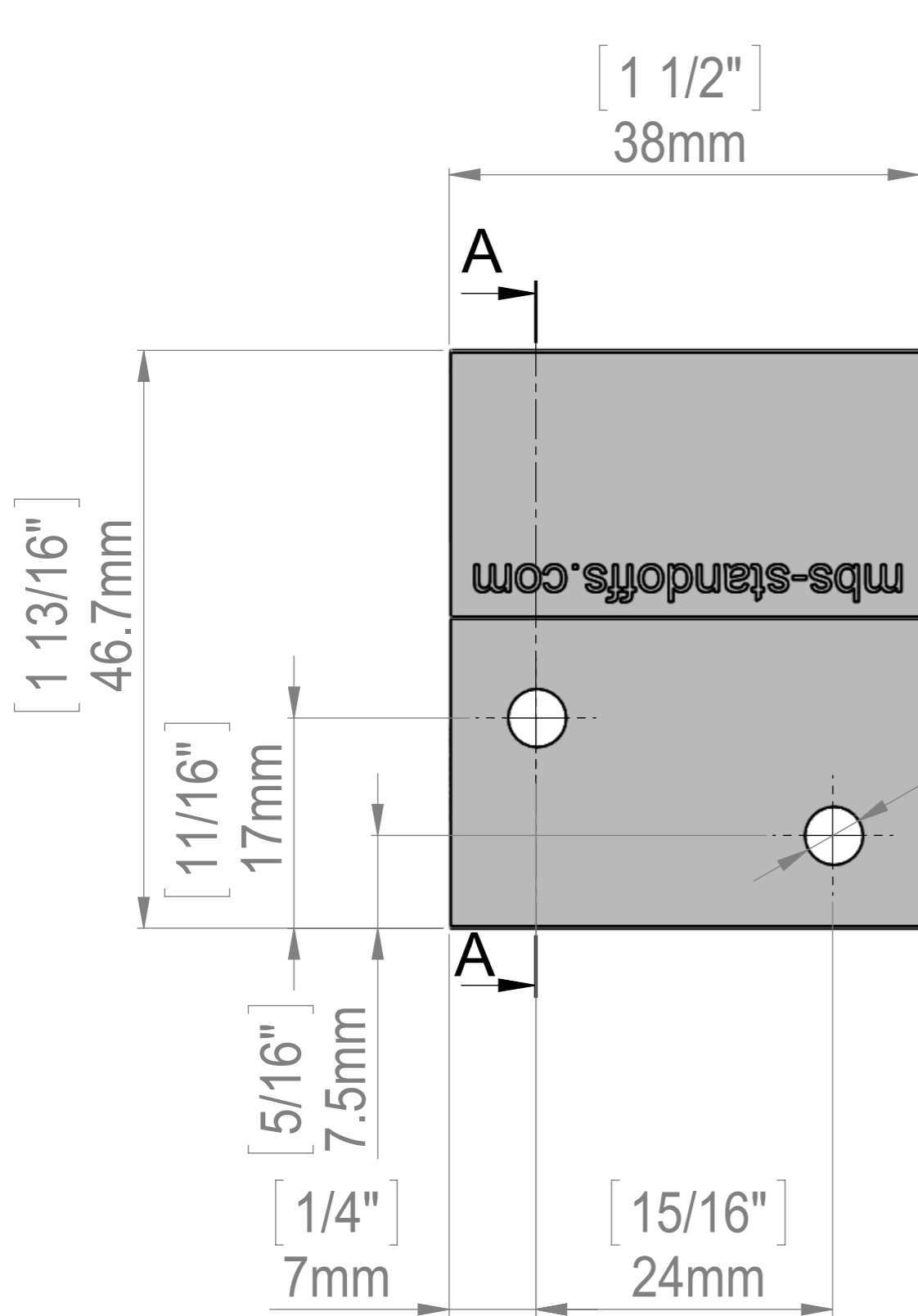

Title : ZCP2			Scale : 2:1	Mbs R&D	
 Mbs Standoffs 6420 Benjamin Rd Tampa, FL 33634 USA 813-938-6025			Sizes : Letter Landscape	Customer:	
Material:			Finish	Qty :	Rep :
N°programme laser			N°prog. Mécanum.	N° Plan : ZCP1-3ft	

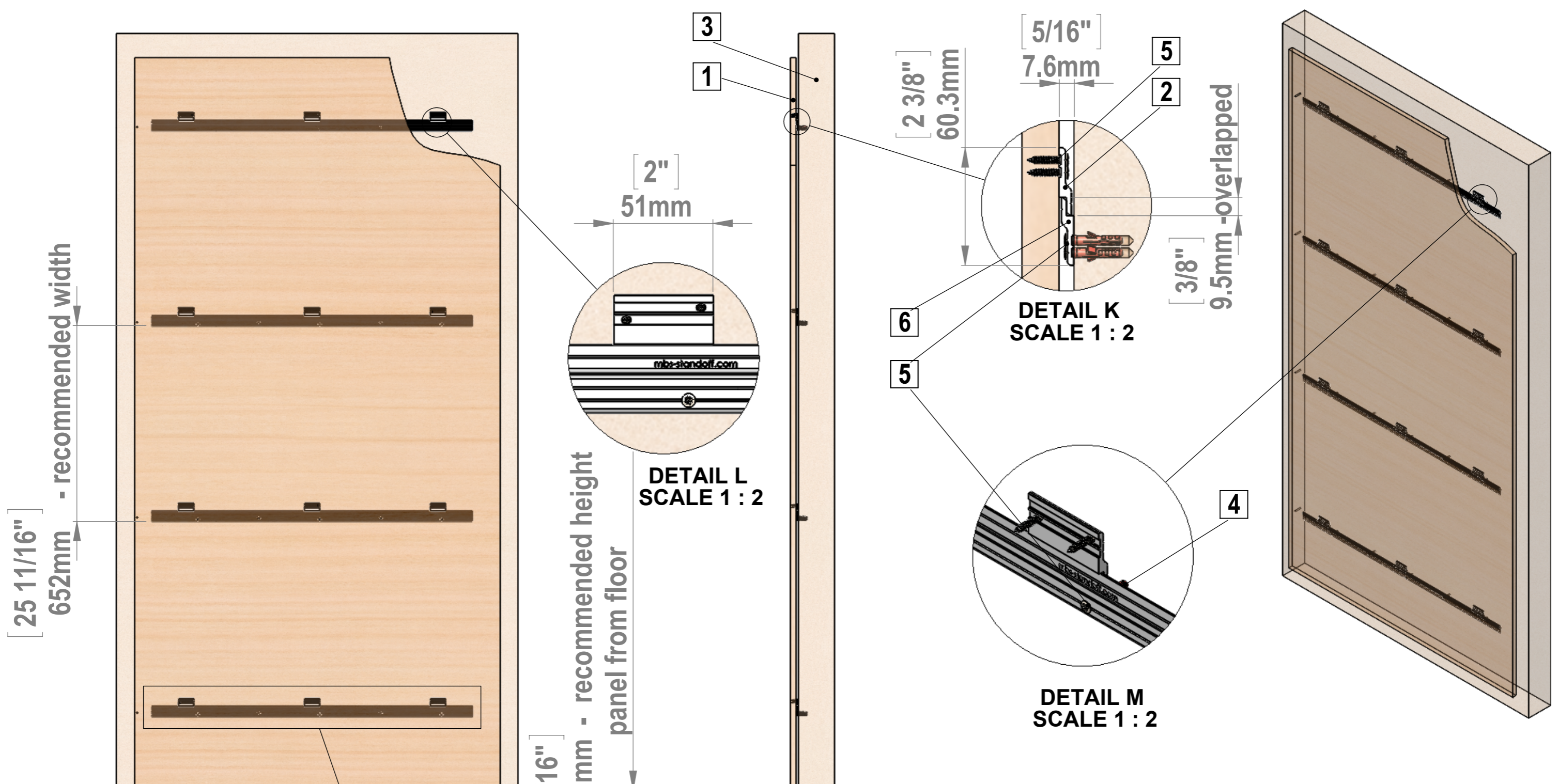

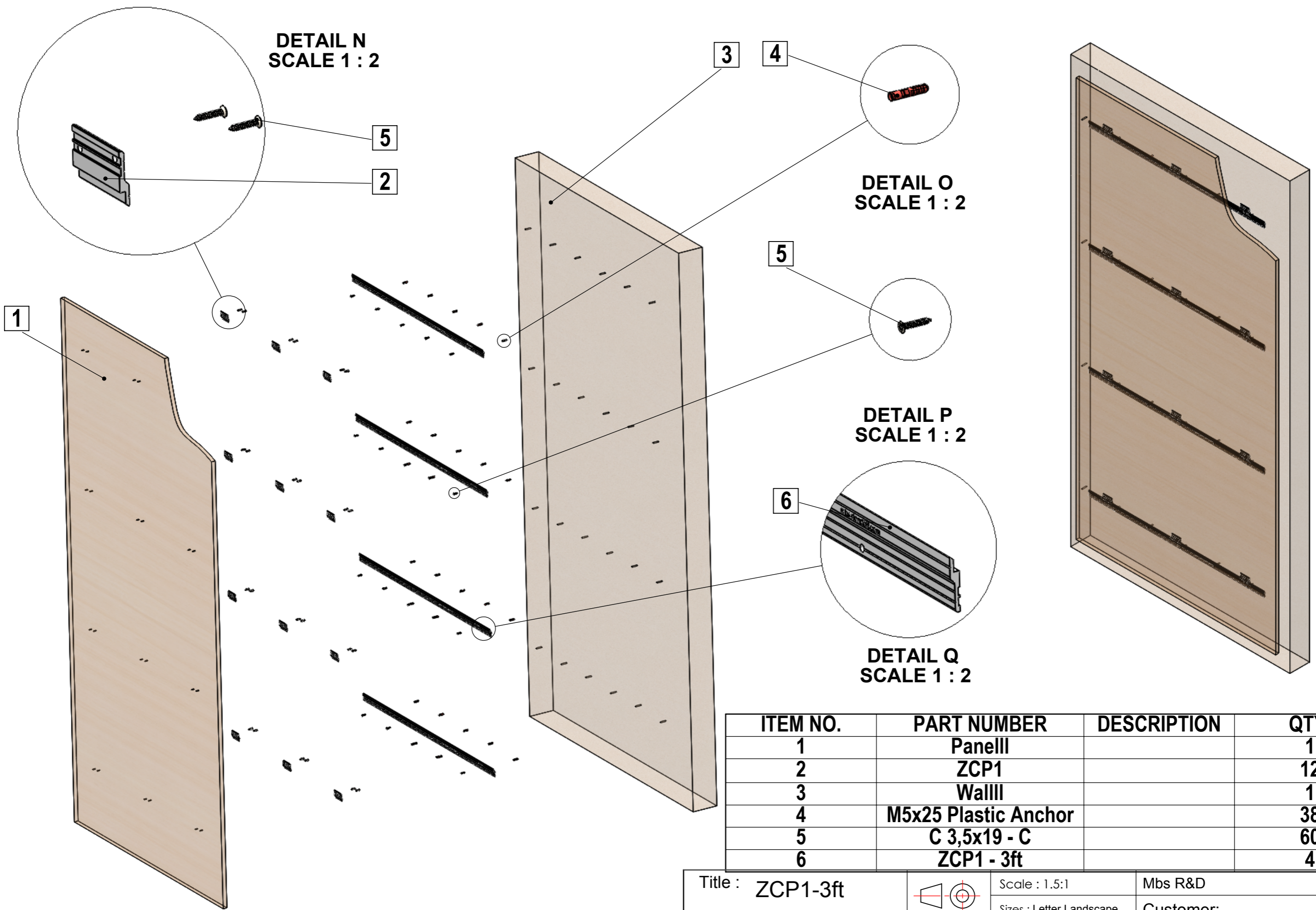

ITEM NO.	PART NUMBER	DESCRIPTION	QTY.
1	PanelI		1
2	ZCP1		12
3	WallI		1
4	M5x25 Plastic Anchor		38
5	C 3,5x19 - C		60
6	ZCP1 - 3ft		4

Title : ZCP1-3ft		Scale : 1:13	Mbs R&D	
		Sizes : Letter Landscape	Customer:	
Material:		Finish	Qty :	Rep :
 Mbs Standoffs 6420 Benjamin Rd Tampa, FL 33634 USA 813-938-6025		N°programme laser	N°prog. Mécanum.	N° Plan : ZCP1-3ft

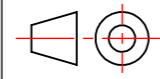

ITEM NO.	PART NUMBER	DESCRIPTION	QTY.
1	Panell		1
2	ZCP1		12
3	Walll		1
4	M5x25 Plastic Anchor		38
5	C 3,5x19 - C		60
6	ZCP1 - 3ft		4

Title : ZCP1-3ft			Scale : 1.5:1	Mbs R&D	
			Sizes : Letter Landscape	Customer:	
 Mbs Standoffs 6420 Benjamin Rd Tampa, FL 33634 USA 813-938-6025	Material:	Finish	Qty :	Rep :	
	N°programme laser	N°prog. Mécanum.	N° Plan : ZCP1-3ft		