

2

1

B

B

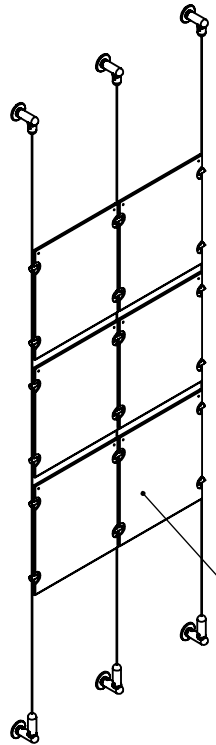

Height Adjustable  
Acrylic and Panel Grippers

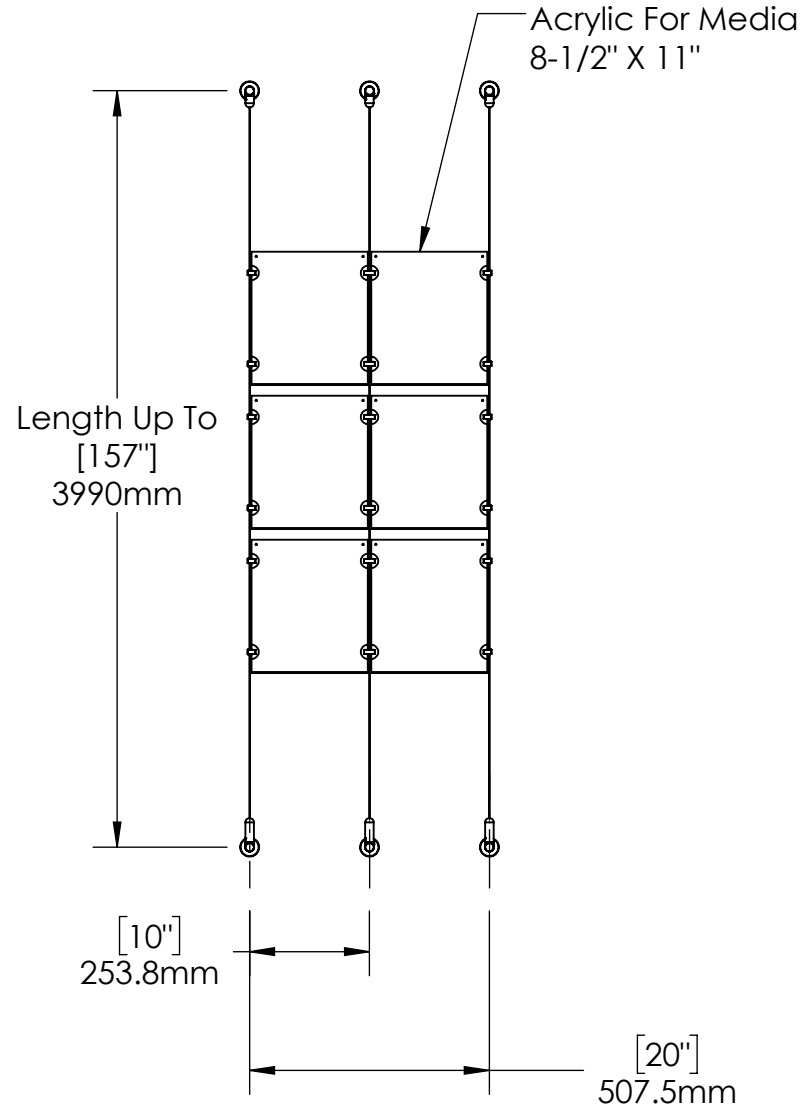

A

A

2

1



**Mbs Standoffs**  
5046 W Linebaugh Ave  
Tampa, FL 33624 USA  
(813) 938-6025

ASSEMBLY NO.

**ACG1908-8511-A2X3**

SCALE: 1:16

SHEET 1 OF 1