

SECTION A-A
SCALE 1.5 : 1

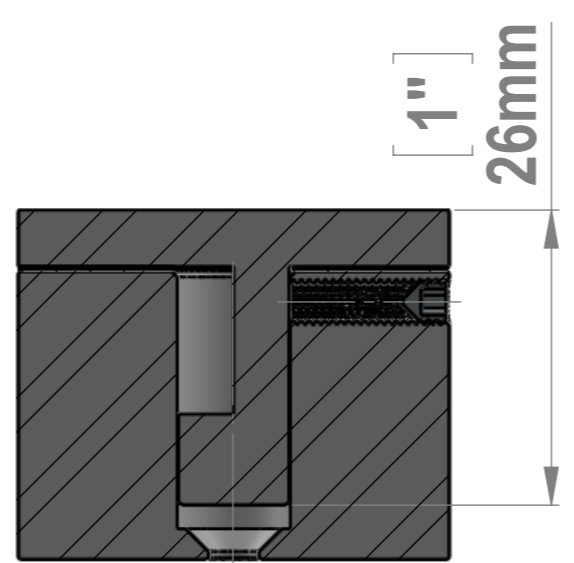

SECTION B-B
SCALE 1.5 : 1

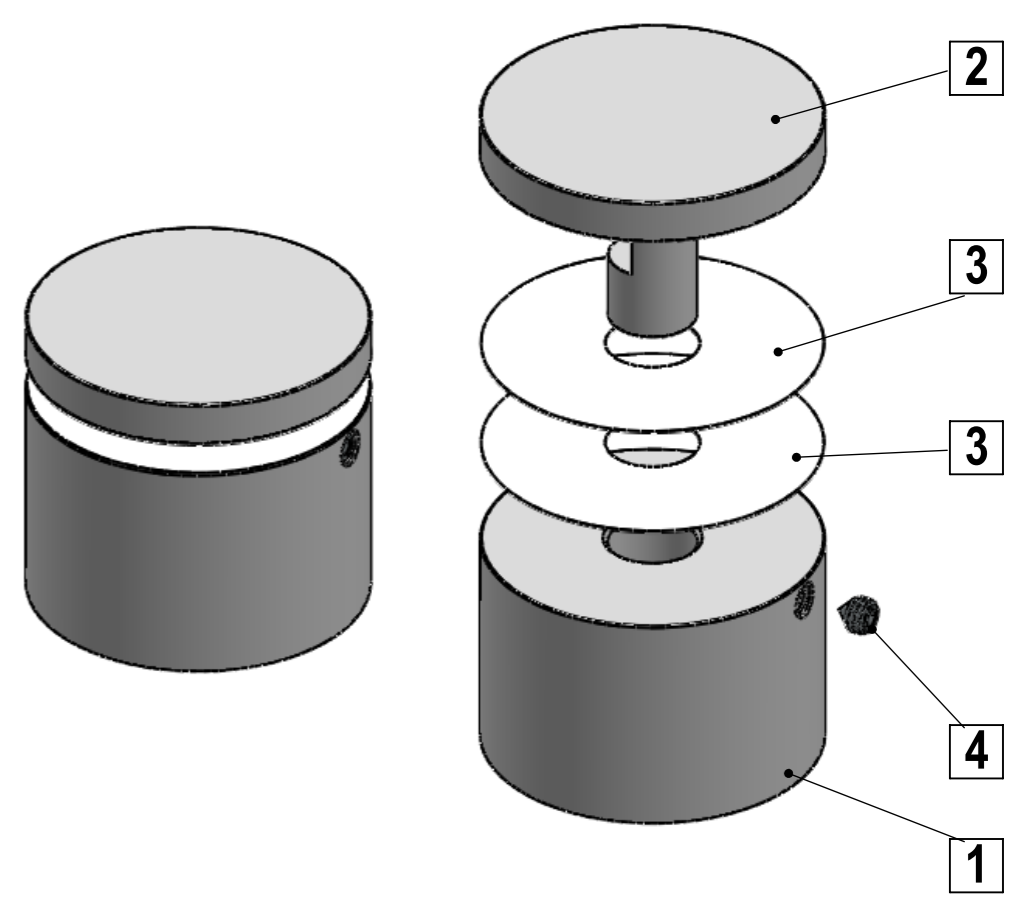

ITEM NO.	PART NUMBER	DESCRIPTION	QTY.
1	EG150-100_Body		1
2	EG150-100_Head		1
3	EG150_Nylon-Washer		2
4	Set_Screw_M4x4mm		1

Title : EG150-100		Scale : 1.2:1	Mbs R&D	
		Sizes : Letter Landscape	Customer:	
Material:		Finish	Qty :	Rep :
N°programme laser		N°prog. Mécanum.	N° Plan : EG150-100	

Mbs Standoffs
6420 Benjamin Rd
Tampa, FL 33634
USA
813-938-6025