

6

5

4

3

2

1

D

D

C

C

B

B

A

A

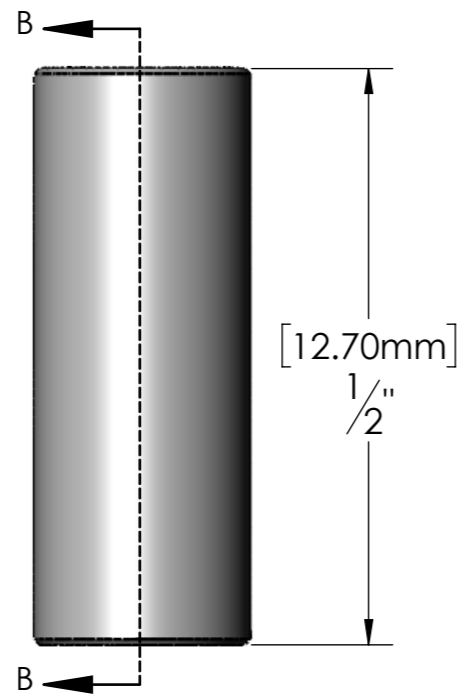
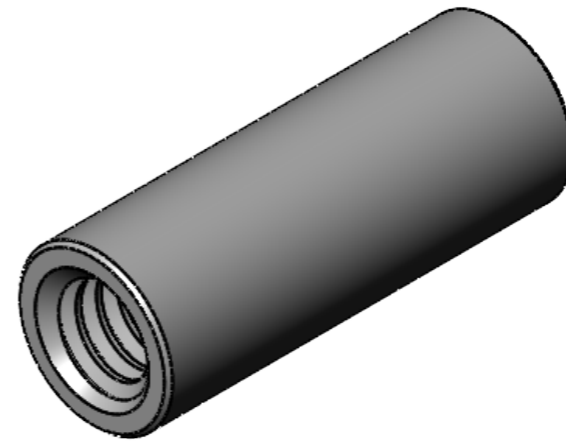
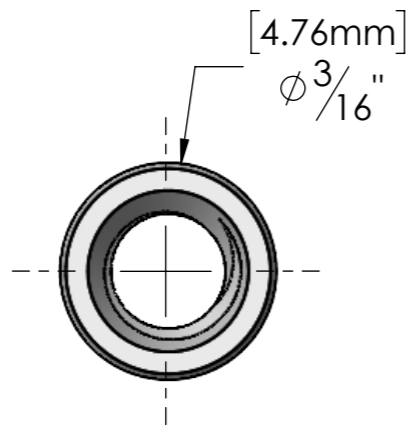

.005in [0.13mm] X 45° typ

4-40 Thread

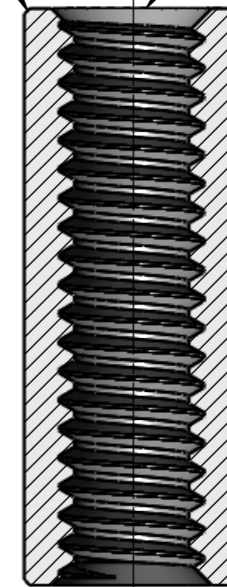

SECTION B-B

TITLE FC1637-440	Tolerance : OD ± .005in [.125mm] ID ± .003in [.075mm] Length ± .005in [.125mm]	Scale: 6:1	Mbs R&D	
		Size: A3	Customer:	
 Mbs Standoffs 5046 W Linebaugh Ave, Tampa, FL 33624 USA 1(813)-938-6025	Material	Finish	Qty:	Rep:
	N' Program laser	N'Prog. Mecanum	Plan:	

6

5

4

3

2

1