

Maximum Material
Thick. Accepted

[1/2"]
12.7mm

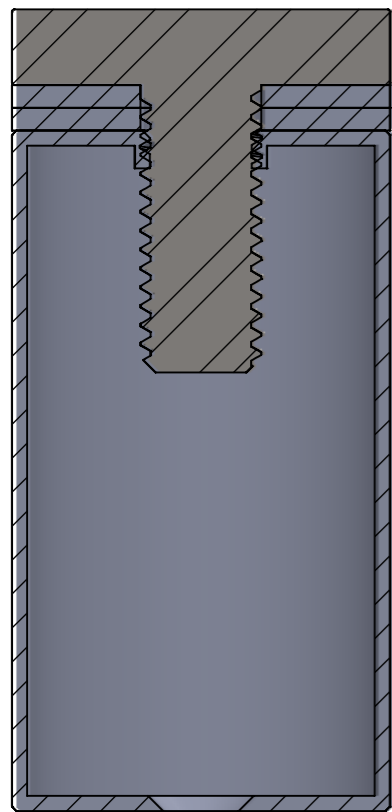

SECTION A-A

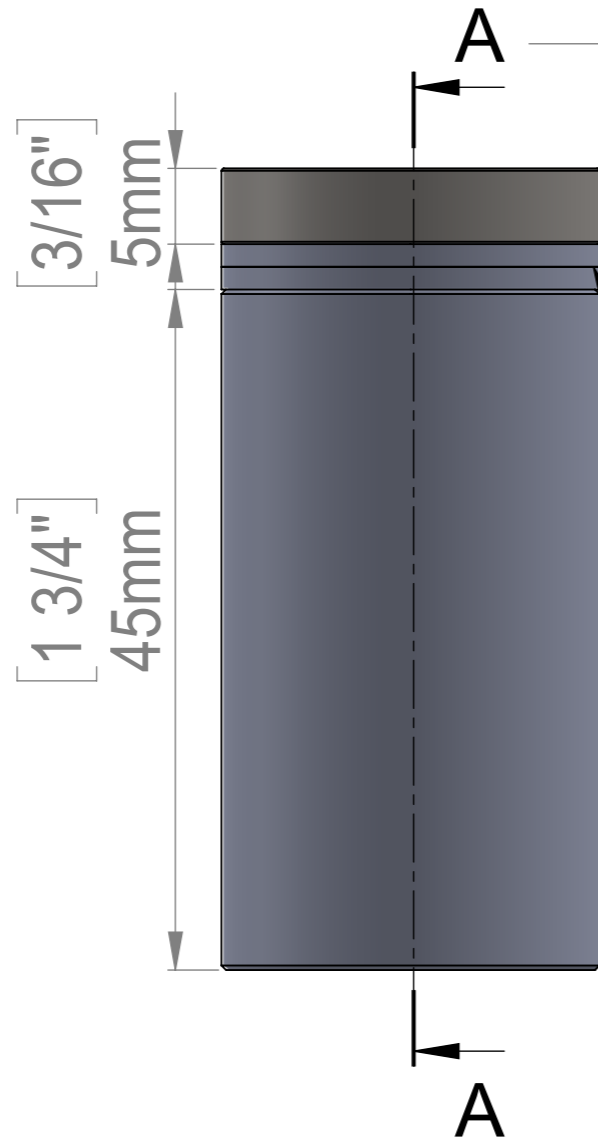

2 Silicone Washer

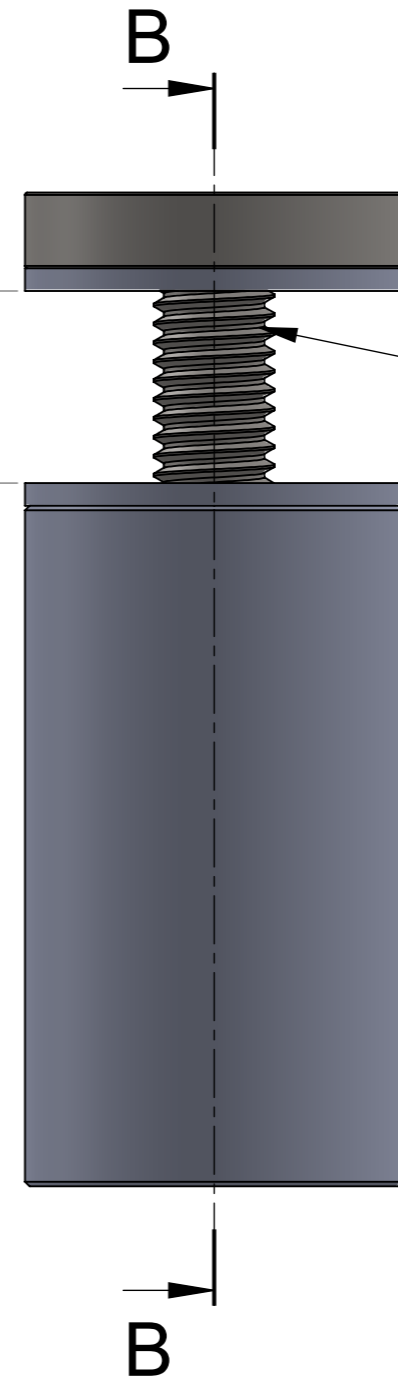

M10 Thread

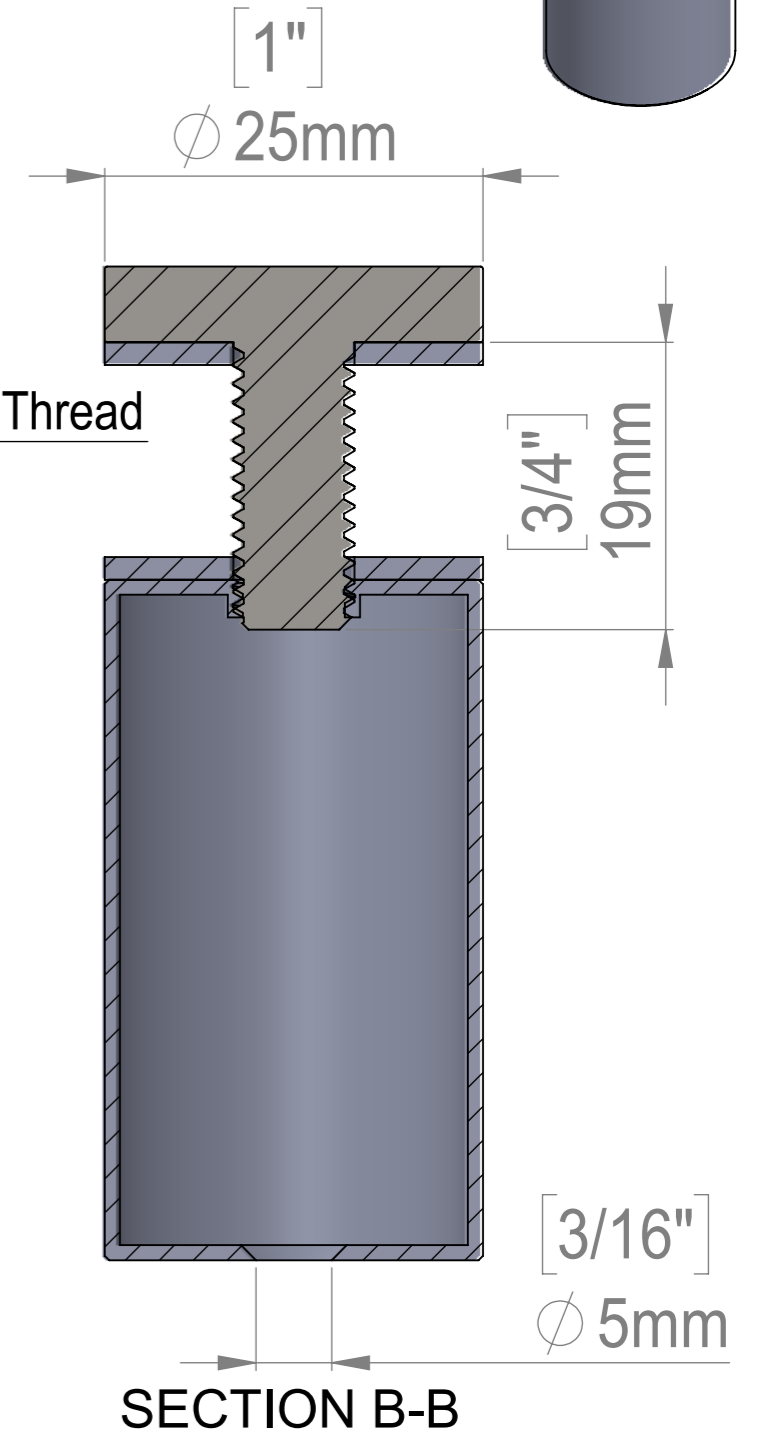

SECTION B-B

Title : HBL *25-50			Scale : 3.5:1	Mbs R&D	
 Htm-Mbs 5046 W Linebaugh Tampa, FL 33624 T: 1-813-938-6025			Sizes : Letter Landscape	Customer:	
Material: Hollow SS201		Finish: Satin Brushed	Qty :	Rep :	
N°programme laser		N°prog. Mécanum.	N°:		