

M10X150 Brass Insert

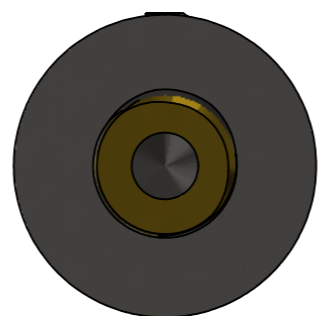
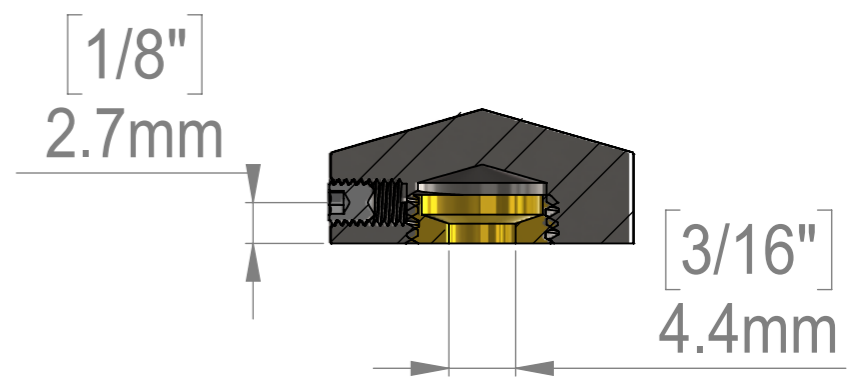
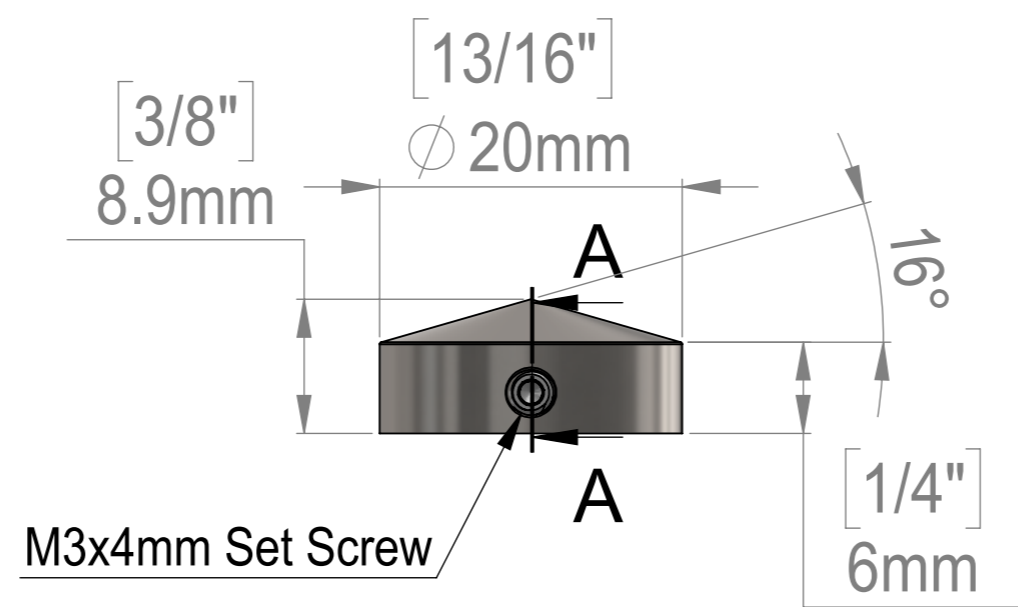
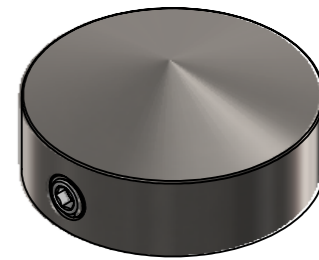
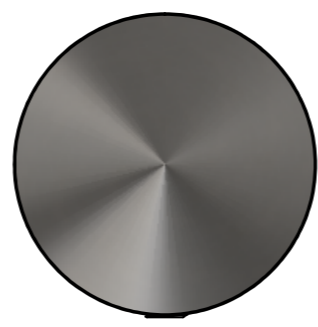

Title : SC20CL			Scale : 2:1	Mbs R&D	
			Sizes : Letter Landscape	Customer:	
	Mbs Standoffs 5046 W Linebaugh Ave Tampa, FL 33624 USA 1 (813) 938-6025	Material:	Finish	Qty :	Rep :
		N°programme laser	N°prog. Mécanum.	N° Plan : FAH25-12	