

SECTION A-A

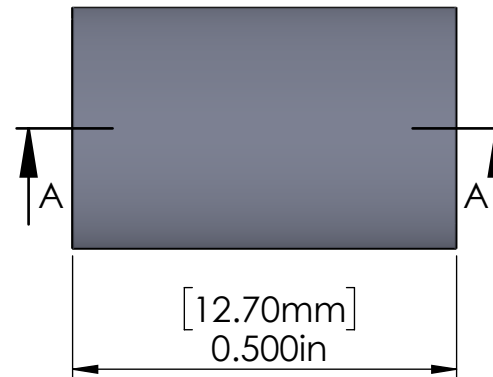
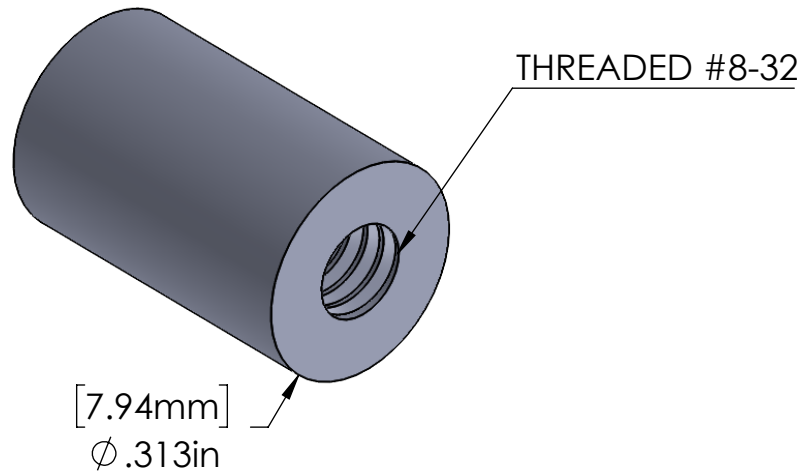

Title: <b>SP31-832-32</b>		 Tolerance OD ± .005in [.125mm] ID ± .003in [.075mm] Length ± .005in [.125mm]	Scale: 4:1	Mbs R&D	
			Sizes: Letter Landscape	Customer:	
 <b>Mbs Standoffs</b> 8420 Benjamin Rd Tampa, FL 33634 USA 813 938 6025	Material: Aluminum 6061-T6	Finish: Plain Aluminum	Qty:	Rep:	
	N° programme laser	N° prog. Mécanum.	N° Plan: SP31-832-32		