

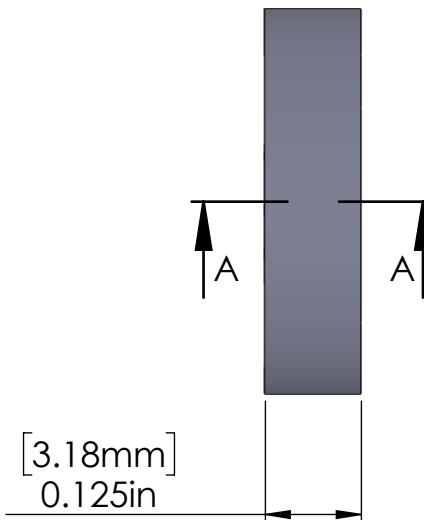

SECTION A-A



Title: SP50-1024-8		 Tolerance OD ± .005in [.125mm] ID ± .003in [.075mm] Length ± .005in [.125mm]		Scale: 4:1	Mbs R&D
				Sizes: Letter Landscape	Customer:
 Mbs Standoffs 8420 Benjamin Rd Tampa, FL 33634 USA 813 938 6025	Material: Aluminum 6061-T6		Finish: Plain Aluminum	Qty:	
	N° programme laser		N° prog. Mécanum.	Rep:	
				N° Plan:	SP50-1024-8