

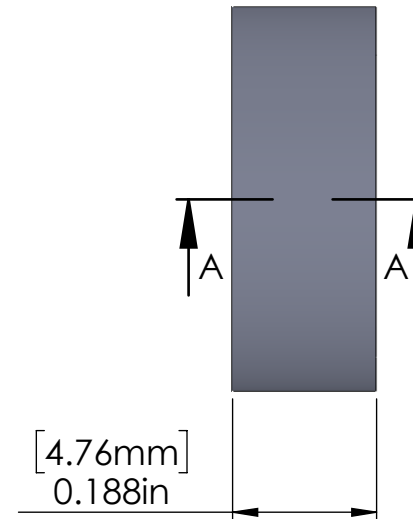

SECTION A-A



Title: <b>SP50-1420-12-BA</b>		 Tolerance OD ± .005in [.125mm] ID ± .003in [.075mm] Length ± .005in [.125mm]	Scale: 4:1	Mbs R&D
			Sizes: Letter Landscape	Customer:
 <b>Mbs Standoffs</b> 8420 Benjamin Rd Tampa, FL 33634 USA 813 938 6025	Material: Aluminum 6061-T6	Finish: Black Anodized	Qty:	Rep:
	N° programme laser	N° prog. Mécanum.	N° Plan: SP50-1420-12-BA	