

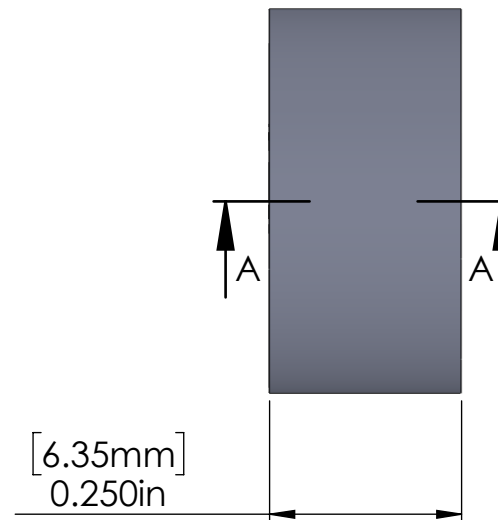

SECTION A-A



Title: <b>SP50-1420-16</b>		 Tolerance OD ± .005in [.125mm] ID ± .003in [.075mm] Length ± .005in [.125mm]		Scale: 4:1		Mbs R&D	
				Sizes: Letter Landscape		Customer:	
 <b>Mbs Standoffs</b> 8420 Benjamin Rd Tampa, FL 33634 USA 813 938 6025		Material: Aluminum 6061-T6		Finish: Plain Aluminum		Qty:	
		N° programme laser		N° prog. Mécanum.		Rep:	
						N° Plan: SP50-1420-16	