

Set of 4 Standoffs

- 4x Cap
- 4x Stud
- 4x Barrel
- 4x Hanger Bolt
- 4x Anchor

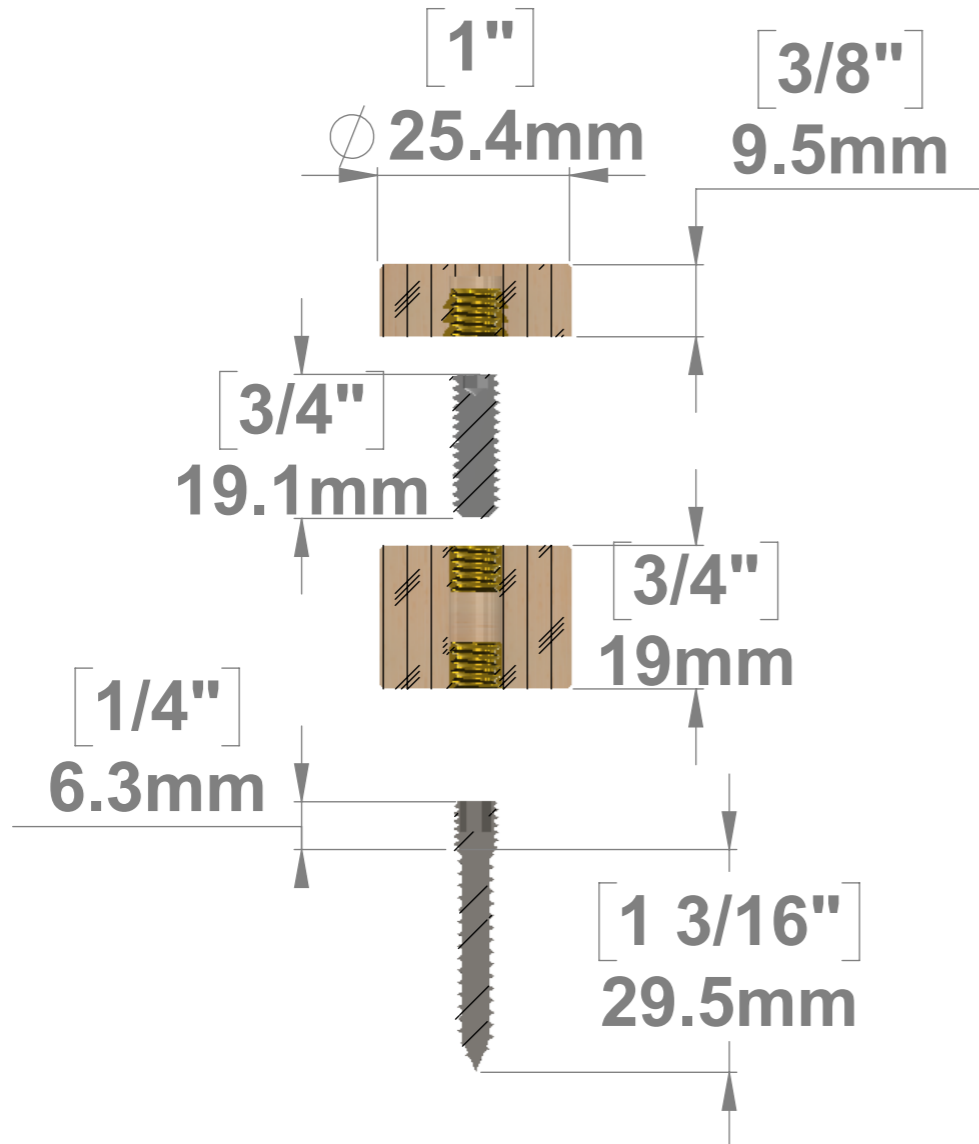

**Concrete / Drywall
Anchor #6
1/4" Drill Diameter**

SECTION A-A

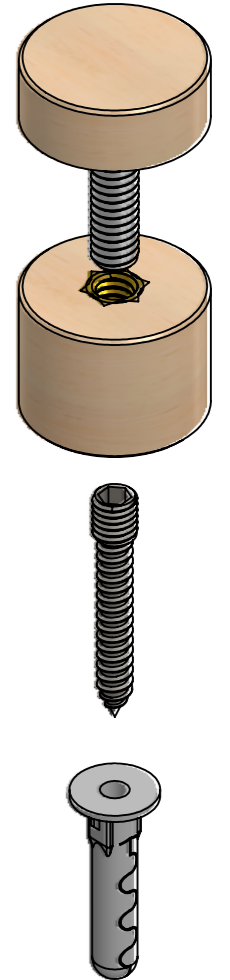
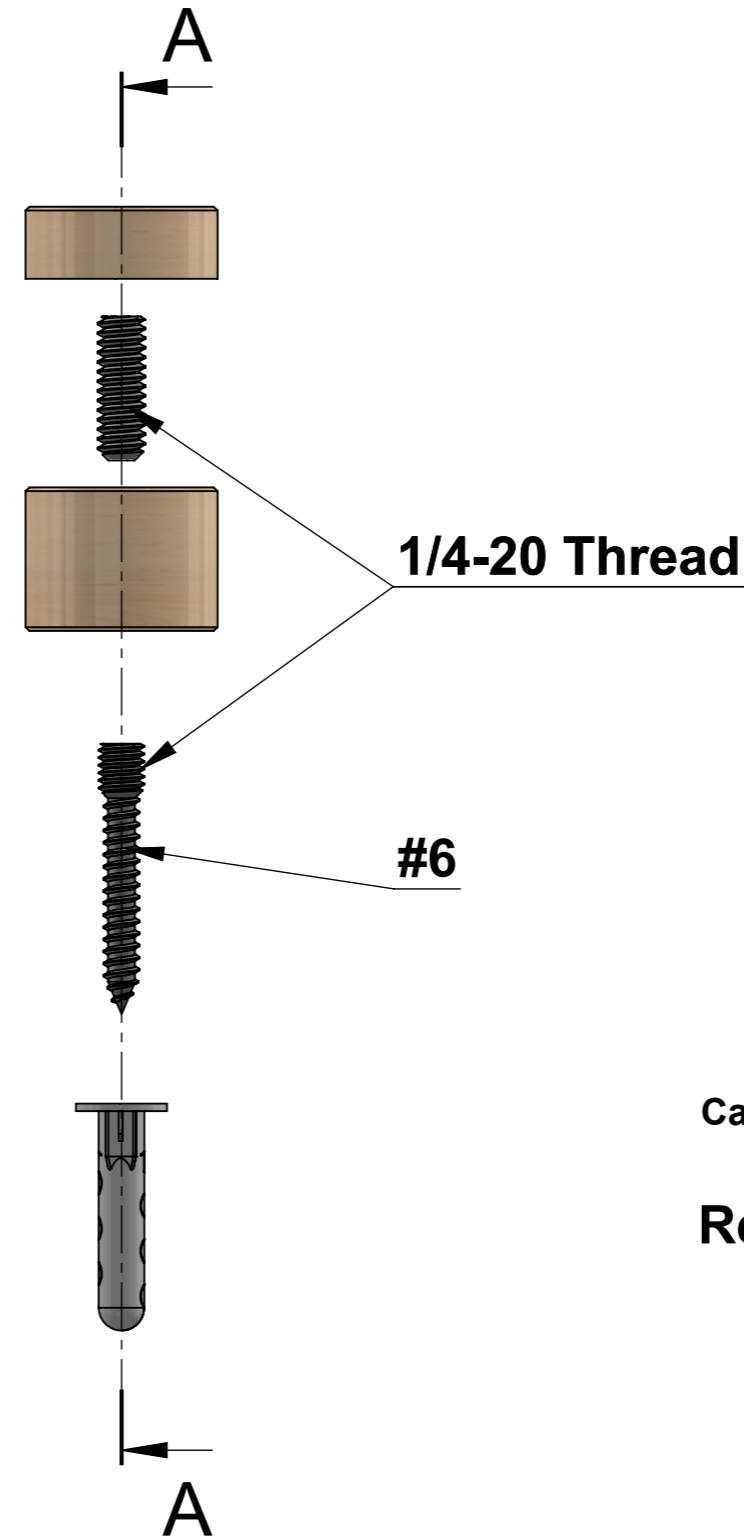

**Material Thickness Accepted
Between 0" to 1/2"**
Can be higher if stud is changed to a longer one

Required Material Hole Size: 5/16"

Title : WS100-100			Scale : 2:1	Mbs R&D	
			Sizes : Letter Landscape	Customer:	
	Mbs Standoffs 5046 W Linebaugh Ave Tampa, FL 33624 USA 1 (813) 938-6025	Material:	Finish	Qty :	Rep :
		N°programme laser	N°prog. Mécanum.	N° Plan : FAH25-12	